



Prices effective February 5, 2018

Published July 2018

Canvas Office Landscape® Beam

Introduction	page 2
Canvas Office Landscape Beam	3
Structure	5
Surfaces	25
Screens	34
Indices	41
By Name	41
By Number	43
Appendices	
20-Day or Less/Assigned Lead-Time Order Information	
Keyed-Alike Information	
Vary Easy Program	
Stain-to-Match Program	
Canvas Office Landscape Connectors and Covers Matrix	
For the latest materials information, refer to the Materials pages on HermanMiller.com.	

Introduction

A Note on the Organization of This Book

There are a few signals that will help you understand the organization of this book. Once you know them, you should be able to find your way around easily.

Like a newspaper, this book is formatted with columns of text and illustrations that run vertically.

Information wraps from one column to the next and continues for as many pages as it needs to.

Black bars are clues.

A black bar at the top of a page signals the start of information about a product.

This information is divided into two sections, each signaled by a black bar. Product Information includes a description, additional notes, and dimensional drawings. Specification Information, which always begins at the top of a column, includes a series of steps. Each step represents a decision you need to make in order to complete your product number. Steps must be followed sequentially. The number of pages needed to complete information on a product varies; some will be complete in one page; others may fill three or four pages. Just continue going through the steps until you run into the next product, signaled by the black bar at the top of the page.

Black tabs running along the outside edge of the page help you locate what section you are in or what section you want to go to. You can thumb forwards or backwards to find a section; tabs and text appear on both sides of the page.

The additional pages in the back of the book include the appendices and indices. They are signaled by a long black bar running along the outside edge of the page.

The index is presented two ways.

The first index is in alphabetical order by product name. It can be helpful if you are new to the products and numbering scheme or if you are looking for a type of product, such as work chair or round table.

The second index is by product number. It lists, in alphanumeric order, the base product number, typically a five-digit number.

This book is effective February 5, 2018, subject to change without notice. Products may be purchased from authorized Herman Miller dealers who will quote prices upon request. For more information about our products and services or to see a list of dealers, visit www.HermanMiller.com.

All prices are list prices in US Dollars. Additional services, such as planning services, design, storage, and installation, are not included and must be added to these prices when the additional services are requested.

Illustrations, specifications, and prices are based on the latest information at the time of publication. The right is reserved to make changes at any time without notice in prices, fabrics, finishes, materials, specifications, and models, and also to discontinue models and finishes.

Dimensions shown in the drawings are engineering drawing dimensions rounded up to the nearest $\frac{1}{8}$ ". Product is shipped set up or knocked down. Products that include "Shipped knocked down" in the description require some assembly. If this statement does not appear in the description, the product is shipped assembled.

Service problems are normally handled by a Herman Miller authorized dealer. Where this cannot be accomplished on a local level, service problems should be referred to the Customer Care Representative for your region, Herman Miller, Inc., Zeeland, Michigan 49464.

20-Day or Less/Assigned Lead-Time Shipments

All products and options in this price book not designated by an Assigned Program icon  will ship in **20 business days or less** after being acknowledged by Herman Miller.

Products and options designated by an  are on the assigned lead-time program and may ship in 20 days, less than 20 days, or more than 20 days from order acknowledgement.

Structure

Surfaces

Screens



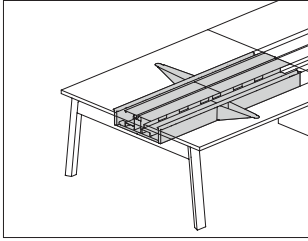

Product Information

Description

This beam attaches to support components and other beams to create the horizontal structure for supporting surfaces in double-sided beam applications. It has a center trough for routing power and data, back-to-back hinged access doors, and a center accessory channel. The trough accommodates modular or hard-wired electrical components. The doors run the entire length of the beam and provide access to the concealed receptacles and data outlets in the trough. The accessory channel allows attachment of an optional beam-attached screen. Receptacle covers, data outlet covers, surface cantilevers, and surface attachment hardware are included.

Notes

Specify 60"-deep option (60) for use with 30"-deep surfaces. Specify 72"-deep option (72) for use with 36"-deep surfaces.

Beam sections of any width can be connected with in-line beam connector (FW123.) to create a run up to 24' long.

48"- and 60"-wide beam sections include 1 surface cantilever per side.

72"- and 96"-wide beam sections include 2 surface cantilevers per side.

For hard-wired electrical, components must be customer supplied.

Order the following products separately:

- Beam accessory channel trim strip (FW124.)
- Beam-attached screen, glass (FW410.)
- End Support, open (FW130.)
- In-line beam connector (FW123.)
- Mid-run support, closed (FW132.)
- Mid-run support, open (FW133.)
- Power harness (FW150.)
- Squared-edge rectangular surface, end position (FW210.)
- Squared-edge rectangular surface, middle position (FW211.)

Dimensions

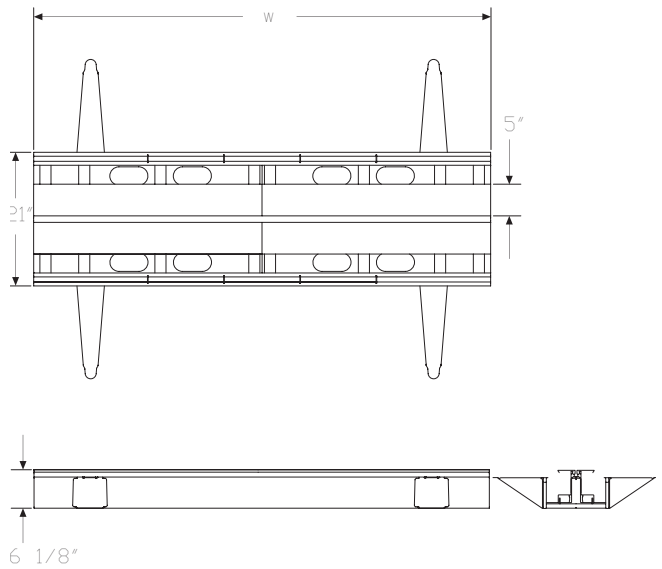

Beam Section, Double-Sided

continued

Canvas Office Landscape® Structure

Specification Information

Step 1.

FW120. A

Step 2. Assembled Table Depth

60 60" deep A

72 72" deep A

Step 3. Width

48 48" wide A

60 60" wide A

72 72" wide A

96 96" wide A

Step 4. Power/Data Access

A continuous access doors A

Prices for Steps 1-4.

	A
FW120. 60 48	\$2274
60	\$2729
72	\$3211
96	\$4060
72 48	\$2394
60	\$2848
72	\$3333
96	\$4181

Step 5. Access Door/Accessory Channel Finish

AN clear anodized aluminum A +\$0

Beam Section, Single-Sided

FW121.

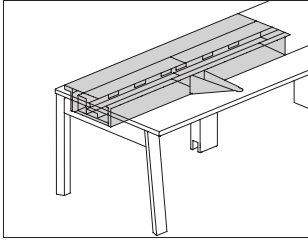

Product Information

Description

This beam attaches to support components and other beams to create the horizontal structure for supporting surfaces in single-sided beam applications. It has a trough for routing power and data, hinged access doors, and an accessory channel. The trough accommodates modular or hard-wired electrical components. The doors run the entire length of the beam and provide access to the concealed receptacles and data outlets in the trough. The accessory channel allows attachment of an optional beam-attached screen. Receptacle covers, data outlet covers, surface cantilevers, and surface attachment hardware are included.

Notes

Specify 30"-deep option (30) for use with 30"-deep surfaces. Specify 36"-deep option (36) for use with 36"-deep surfaces.

Beam sections of any width can be connected to create a run up to 24' long.

48"- and 60"-wide beam sections include 1 surface cantilever. 72"- and 96"-wide beam sections include 2 surface cantilevers.

For hard-wired electrical, components must be customer supplied.

Order the following products separately:

In-line beam connector (FW123.)

End Support, open (FW130.)

Mid-run support, closed (FW132.)

Mid-run support, open (FW133.)

Power harness (FW150.)

Squared-edge Rectangular Surface, End Position (FW210.)

Squared-edge Rectangular Surface, Middle Position (FW211.)

Beam Accessory Channel Trim Strip (FW124.)

Dimensions

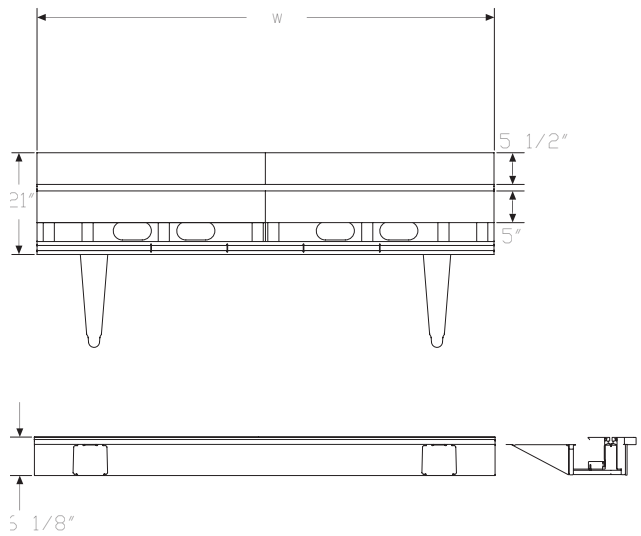

Beam Section, Single-Sided

continued

Specification Information	
Step 1.	
FW121.	<input type="checkbox"/> A
Step 2. Assembled Table Depth	
30	30" deep <input type="checkbox"/> A
36	36" deep <input type="checkbox"/> A
Step 3. Width	
48	48" wide <input type="checkbox"/> A
60	60" wide <input type="checkbox"/> A
72	72" wide <input type="checkbox"/> A
96	96" wide <input type="checkbox"/> A
Step 4. Power/Data Access	
A	continuous access doors <input type="checkbox"/> A
Prices for Steps 1-4.	
	A
FW121. 30 48	\$2053
60	\$2464
72	\$2901
96	\$3667
36 48	\$2112
60	\$2522
72	\$2961
96	\$3725
Step 5. Access Door/Accessory Channel Finish	
AN	clear anodized aluminum <input type="checkbox"/> A +\$0
Step 6. Back Panel Finish	
8Q	folkstone grey <input type="checkbox"/> A +\$0
91	white <input type="checkbox"/> A +\$0
98	studio white <input type="checkbox"/> A +\$0
G1	graphite <input type="checkbox"/> A +\$0
WL	sandstone <input type="checkbox"/> A +\$0
MS	metallic silver <input type="checkbox"/> A +\$0

In-Line Beam Connector

FW123.

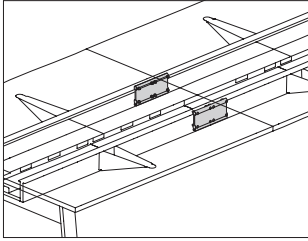

Product Information

Description

This connector joins two single-sided or double-sided beam sections in-line to create longer beam lengths. Attachment hardware and a ganging plate for securing adjacent surfaces are included.

Notes

Order the following products separately:

- Beam section, double-sided (FW120.)
- Beam section, single-sided (FW121.)

Dimensions

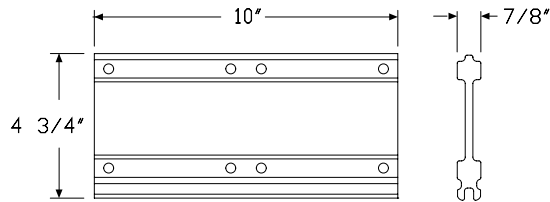

Specification Information

Step 1.

FW123. A

Step 2. Type

S for single-sided beam section A

D for double-sided beam section A

Prices for Steps 1-2.

FW123.S	\$189
D	\$189

Trim Strip, Beam Accessory
Channel

FW124.

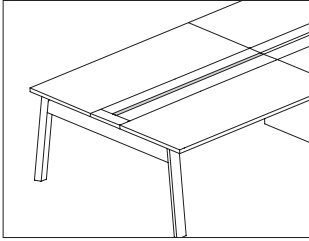

Canvas Office Landscape® Structure

Product Information

Description

This aluminum trim strip can be used to fill an unused section of the beam accessory channel. It can be field cut to the desired length.

Notes

Trim strip does not need to match the width of the beam section.

Dimensions



Specification Information

Step 1.

FW124. A

Step 2. Length

- 48** 48" long A
- 60** 60" long A
- 72** 72" long A
- 96** 96" long A

Prices for Steps 1-2.

FW124. 48	\$108
60	\$130
72	\$152
96	\$194

Step 3. Surface Finish

AN clear anodized aluminum A + \$0

End Support, Open

FW130.

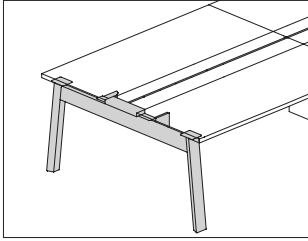

Product Information

Description

This support attaches to either end of a single-sided or double-sided beam run and has glides that provide 2" of leveling adjustment. A power/data trough end cap and attachment hardware are included.

Notes

For appropriate planning and stability requirements, see Canvas Planning Guide.

Dimensions

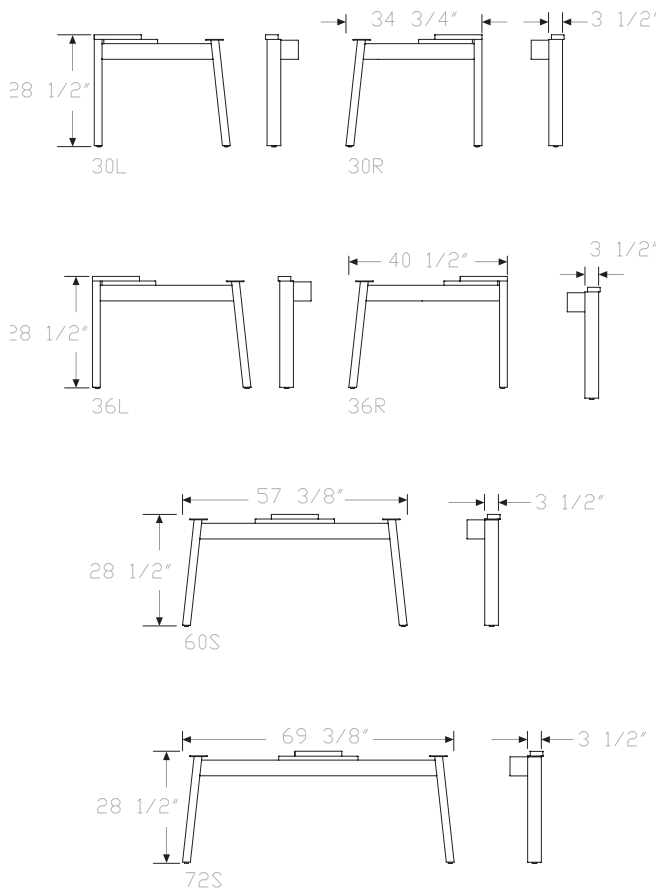

Specification Information

Step 1.

FW130. [A]

Step 2. Depth

- 30L** 30" deep single-sided, left-hand [A]
- 30R** 30" deep single-sided, right-hand [A]
- 36L** 36" deep single-sided, left-hand [A]
- 36R** 36" deep single-sided, right-hand [A]
- 60S** 60" deep double-sided, non-handed [A]
- 72S** 72" deep double-sided, non-handed [A]

Step 3. Power/Data Access

A for use with beam with access doors [A]

Prices for Steps 1-3.

	A
FW130. 30L	\$1387
30R	\$1387
36L	\$1439
36R	\$1439
60S	\$1464
72S	\$1517

Step 4. Leg Body/Horizontal Cross Bar Finish

8Q folkstone grey [A]	+\$0
91 white [A]	+\$0
98 studio white [A]	+\$0
G1 graphite [A]	+\$0
WL sandstone [A]	+\$0
MS metallic silver [A]	+\$0

Step 5. Leg Face Finish

8Q folkstone grey [A]	+\$0
91 white [A]	+\$0
98 studio white [A]	+\$0
G2 graphite satin [A]	+\$0
WL sandstone [A]	+\$0
MS metallic silver [A]	+\$0
AN clear anodized aluminum [A]	+\$20

Step 6. Power/Data Trough End Cap Finish

AN clear anodized aluminum [A]	+\$0
---------------------------------------	------

Mid-Run Support, Open

FW133.

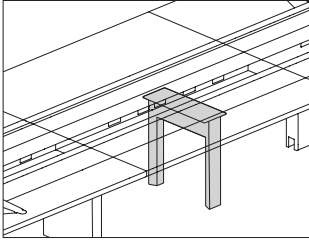

Canvas Office Landscape® Structure

Product Information

Description

This support attaches between end supports on double-sided beam runs greater than 12' long and has glides that provide 2" of leveling adjustment. Attachment hardware is included.

Notes

Support can attach to beam sections in 6" intervals.

Power/Data cannot be routed through the support.

For appropriate planning and stability requirements, see Canvas Planning Guide.

Dimensions

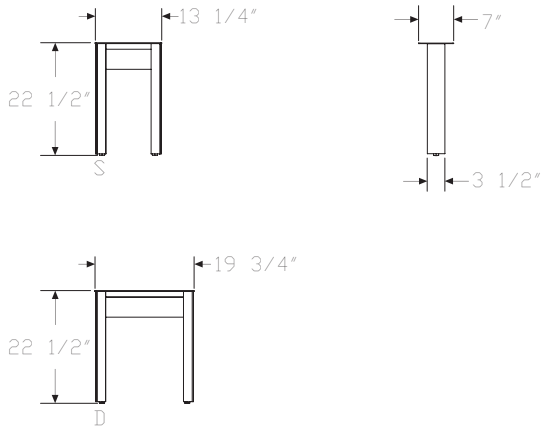

Specification Information

Step 1.

FW133. A

Step 2. Depth

S for single-sided beam section A

D for double-sided beam section A

Prices for Steps 1-2.

FW133. S	\$975
D	\$862

Step 3. Support Body Finish

8Q	folkstone grey <input type="checkbox"/> A	+\$0
91	white <input type="checkbox"/> A	+\$0
98	studio white <input type="checkbox"/> A	+\$0
G1	graphite <input type="checkbox"/> A	+\$0
WL	sandstone <input type="checkbox"/> A	+\$0
MS	metallic silver <input type="checkbox"/> A	+\$0

Step 4. Support Face Finish

8Q	folkstone grey <input type="checkbox"/> A	+\$0
91	white <input type="checkbox"/> A	+\$0
98	studio white <input type="checkbox"/> A	+\$0
G2	graphite satin <input type="checkbox"/> A	+\$0
WL	sandstone <input type="checkbox"/> A	+\$0
MS	metallic silver <input type="checkbox"/> A	+\$0
AN	clear anodized aluminum <input type="checkbox"/> A	+\$20

Mid-Run Support, Closed

FW132.

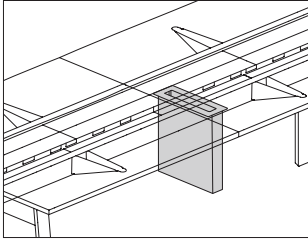

Product Information

Description

This support attaches between end supports on double-sided beam runs greater than 12' long. It can be specified with or without the ability to route power/data inside the support from the floor to the beam section. The support has glides that provide 2" of leveling adjustment. Attachment hardware is included.

Notes

Support can attach to beam sections in 6" intervals.
For appropriate planning and stability requirements, see Canvas Planning Guide.

Dimensions

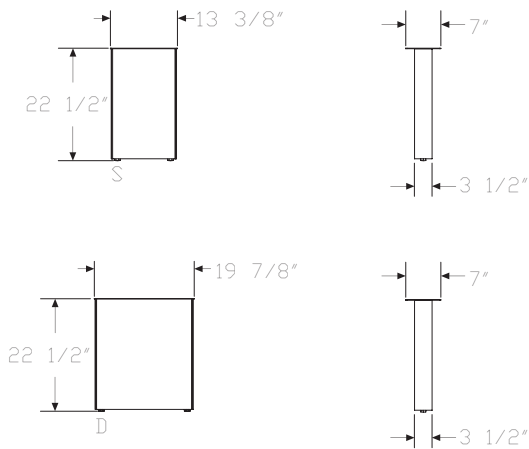

Specification Information

Step 1.

FW132. A

Step 2. Depth

S for single-sided beam section A

D for double-sided beam section A

Step 3. Power

P powered A

N nonpowered A

Prices for Steps 1-3.

	P	N
FW132. S	\$811	811
D	\$709	709

Step 4. Support Body Finish

8Q	folkstone grey <input type="checkbox"/> A	+\$0
91	white <input type="checkbox"/> A	+\$0
98	studio white <input type="checkbox"/> A	+\$0
G1	graphite <input type="checkbox"/> A	+\$0
WL	sandstone <input type="checkbox"/> A	+\$0
MS	metallic silver <input type="checkbox"/> A	+\$0

Step 5. Support Face Finish

8Q	folkstone grey <input type="checkbox"/> A	+\$0
91	white <input type="checkbox"/> A	+\$0
98	studio white <input type="checkbox"/> A	+\$0
G2	graphite satin <input type="checkbox"/> A	+\$0
WL	sandstone <input type="checkbox"/> A	+\$0
MS	metallic silver <input type="checkbox"/> A	+\$0
AN	clear anodized aluminum <input type="checkbox"/> A	+\$20

Power Harness

FW150.

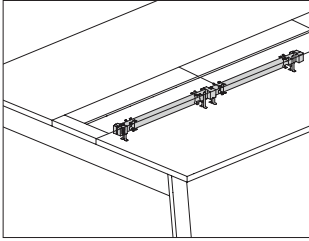

Canvas Office Landscape® Structure

Product Information

Description
 This harness converts a nonpowered beam section to a powered beam section. It distributes up to 4 20-amp circuits and provides receptacle locations on both sides. The harness is UL listed and Canadian UL listed.

Notes
 Match power harness width to beam section width.
 48", 60", and 72"-wide harnesses provide 8 receptacle locations; 4 per side.
 96"-wide harnesses provide 16 receptacle locations; 8 per side.

Dimensions

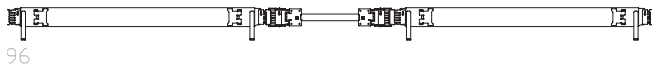
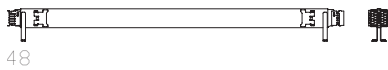

Specification Information

Step 1.

FW150. A

Step 2. Configuration

08 8-wire, 4-circuit, shared neutral A

10 10-wire, 4-circuit, separate neutrals A

Step 3. Width

48 48" wide A

60 60" wide A

72 72" wide A

96 96" wide A

Prices for Steps 1-3.

	48	60	72	96
FW150.08	\$238	277	316	432
10	\$274	319	364	497

Harness-to-Harness Jumper

FW151.

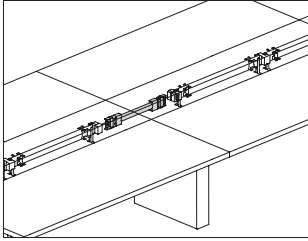

Product Information

Description

This power jumper is used to connect power harnesses in adjacent beam sections. It connects into the end of each harness without consuming any receptacle locations. The power jumper is UL listed and Canadian UL listed.

Notes

Specify 8-wire jumper to connect 8-wire power harnesses. Specify 10-wire jumper to connect 10-wire power harnesses.

Dimensions

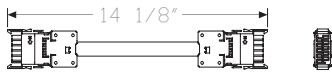

Specification Information

Step 1.

FW151. A

Step 2. Configuration

08 8-wire, 4-circuit, shared neutral A

10 10-wire, 4-circuit, separate neutrals A

Step 3. Jumper Application

S for straight harness connections A

Prices for Steps 1-3.

	S
FW151.08	\$92
10	\$107

Power Entry, Internal Direct Connect

FW140.

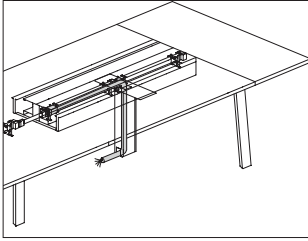

Canvas Office Landscape® Structure

Product Information

Description
 This power entry connects a building's electrical supply from a wall, floor, or column to a powered beam. It enters through a powered closed mid-run support or a floor power entry cover and routes into the underside of a beam section. The power entry plugs into a receptacle location on a power harness and includes a cable that can be field cut to the appropriate length. It is UL listed and Canadian UL listed.

Notes
 A licensed electrician must wire the power entry.

Dimensions

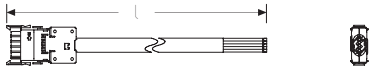

Specification Information

Step 1.

FW140. A

Step 2. Configuration

- 08** 8-wire, 4-circuit, shared neutral A
- 10** 10-wire, 4-circuit, separate neutrals A

Step 3. Length

- 06** 6' long A
- 12** 12' long A
- 18** 18' long A
- 24** 24' long A

Prices for Steps 1-3.

	06	12	18	24
FW140.08	\$180	250	304	360
10	\$207	288	350	414

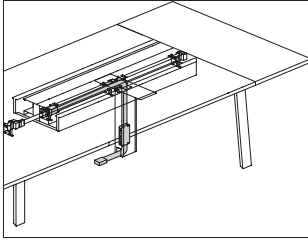

Product Information

Description

This power entry connects a building's electrical supply from a wall, floor, or column to a powered beam. It includes a junction box and harness. The junction box can be located inside a powered closed mid-run support or a floor power entry cover. The modular harness routes into the underside of a beam section and plugs into a receptacle location on a power harness. It is UL listed and Canadian UL listed.

Notes

A licensed electrician must wire the power entry.

Dimensions

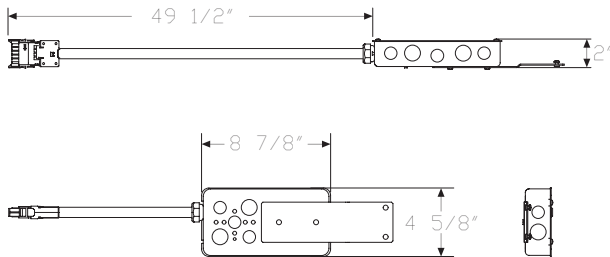

Specification Information

Step 1.

FW141. [A]

Step 2. Configuration

08 8-wire, 4-circuit, shared neutral [A]

10 10-wire, 4-circuit, separate neutrals [A]

Prices for Steps 1-2.

FW141.08	\$332
10	\$382

Floor Power Entry Cover

FW143.

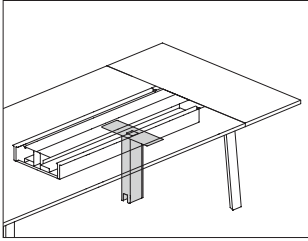

Canvas Office Landscape® Structure

Product Information

Description
This cover is used to conceal a floor power entry from the floor to the underside of a beam section. It has a removable panel on 1 side to provide easy access to the interior. Attachment hardware is included.

Notes
Cover does not provide support for beam sections.

Dimensions

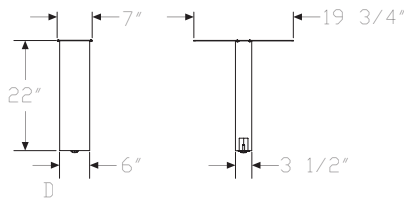
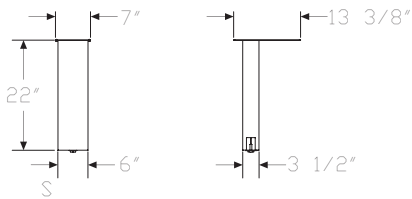

Specification Information

Step 1.

FW143.

Step 2. Type

S for single-sided beam section

D for double-sided beam section

Prices for Steps 1-2.

FW143. S	\$388
D	\$398

Step 3. Support Body Finish

8Q	folkstone grey <input type="checkbox"/>	+ \$0
91	white <input type="checkbox"/>	+ \$0
98	studio white <input type="checkbox"/>	+ \$0
G1	graphite <input type="checkbox"/>	+ \$0
WL	sandstone <input type="checkbox"/>	+ \$0
MS	metallic silver <input type="checkbox"/>	+ \$0

Receptacle, 4-Circuit, 15 Amp

FW152.

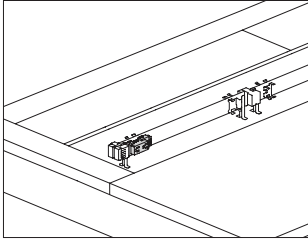

Product Information

Description

This receptacle locks into the power harness of a beam. It is UL listed and Canadian UL listed.

Package contains 6 receptacles.

Dimensions

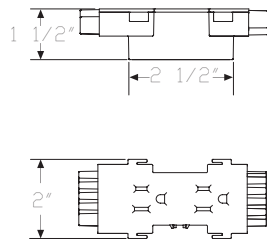

Specification Information

Step 1.

FW152. A

Step 2. Type

- AN** 8-wire duplex, shared neutral, circuit a A
- BN** 8-wire duplex, shared neutral, circuit b A
- CN** 8-wire duplex, shared neutral, circuit c A
- DN** 8-wire duplex, shared neutral, circuit d A
- AG** 8-wire duplex, shared neutral, circuit a, isolated ground A
- BG** 8-wire duplex, shared neutral, circuit b, isolated ground A
- CG** 8-wire duplex, shared neutral, circuit c, isolated ground A
- DG** 8-wire duplex, shared neutral, circuit d, isolated ground A
- 1N** 10-wire duplex, separate neutrals, circuit 1 A
- 2N** 10-wire duplex, separate neutrals, circuit 2 A
- 3N** 10-wire duplex, separate neutrals, circuit 3 A
- 4N** 10-wire duplex, separate neutrals, circuit 4 A
- 1G** 10-wire duplex, separate neutrals, circuit 1, isolated ground A
- 2G** 10-wire duplex, separate neutrals, circuit 2, isolated ground A
- 3G** 10-wire duplex, separate neutrals, circuit 3, isolated ground A
- 4G** 10-wire duplex, separate neutrals, circuit 4, isolated ground A

Prices for Steps 1-2.

FW152.AN	\$150
BN	\$150
CN	\$150
DN	\$150
AG	\$150
BG	\$150
CG	\$150
DG	\$150
1N	\$150
2N	\$150
3N	\$150
4N	\$150
1G	\$150
2G	\$150
3G	\$150
4G	\$150

Step 3. Finish

- 91** white A +\$0
- BK** black A +\$0

Controlled Receptacle, 4-Circuit, FW152M 15 Amp

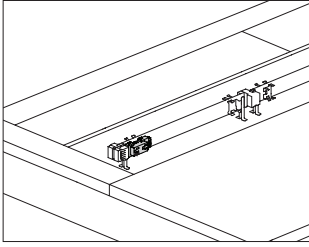

Canvas Office Landscape® Structure

Product Information

Description

This receptacle is to be used for ASHRAE90.1 and Title 24 compliance. A controlled receptacle should be used for any receptacles that are under automated control by the energy management system. The receptacle locks into the power harness of a beam. Package contains 6 receptacles. It is UL listed and Canadian UL listed.

Dimensions

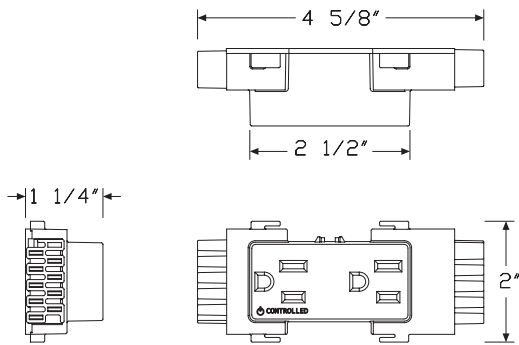

Specification Information

Step 1.

FW152M. A

Step 2. Type

- AN** 8-wire duplex, shared neutral, circuit a A
- BN** 8-wire duplex, shared neutral, circuit b A
- CN** 8-wire duplex, shared neutral, circuit c A
- DN** 8-wire duplex, shared neutral, circuit d A
- AG** 8-wire duplex, shared neutral, circuit a, isolated ground A
- BG** 8-wire duplex, shared neutral, circuit b, isolated ground A
- CG** 8-wire duplex, shared neutral, circuit c, isolated ground A
- DG** 8-wire duplex, shared neutral, circuit d, isolated ground A
- 1N** 10-wire duplex, separate neutrals, circuit 1 A
- 2N** 10-wire duplex, separate neutrals, circuit 2 A
- 3N** 10-wire duplex, separate neutrals, circuit 3 A
- 4N** 10-wire duplex, separate neutrals, circuit 4 A
- 1G** 10-wire duplex, separate neutrals, circuit 1, isolated ground A
- 2G** 10-wire duplex, separate neutrals, circuit 2, isolated ground A
- 3G** 10-wire duplex, separate neutrals, circuit 3, isolated ground A
- 4G** 10-wire duplex, separate neutrals, circuit 4, isolated ground A

Prices for Steps 1-2.

FW152M. AN	\$150
BN	\$150
CN	\$150
DN	\$150
AG	\$150
BG	\$150
CG	\$150
DG	\$150
1N	\$150
2N	\$150
3N	\$150
4N	\$150
1G	\$150
2G	\$150
3G	\$150
4G	\$150

Step 3. Finish

91 white <input type="checkbox"/> A	+\$0
BK black <input type="checkbox"/> A	+\$0

Receptacle, 4-Circuit, 20 Amp

FW153.

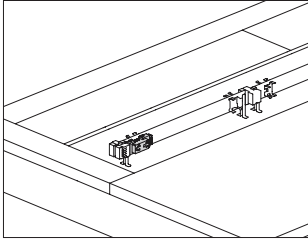

Product Information

Description

This receptacle snaps into a 8-wire, 4-circuit, shared neutral power harness or a 10-wire, 4-circuit, separate neutral power harness to provide power to equipment with a 20-amp standard plug head or cap. It also accepts 15-amp standard plug heads or caps. The receptacle is UL listed; includes 1 receptacle.

Notes

Avoid overloading circuit by ensuring total connected load does not exceed 16 amps. If 1 piece of equipment requires all available power, do not use receptacle's second outlet or install additional receptacles on that circuit. In many cases, equipment requiring this receptacle will use all available power.

Dimensions

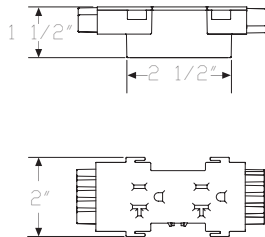

Specification Information

Step 1.

FW153. A

Step 2. Type

- AN** 8-wire duplex, shared neutral, circuit a A
- BN** 8-wire duplex, shared neutral, circuit b A
- AG** 8-wire duplex, shared neutral, circuit a, isolated ground A
- BG** 8-wire duplex, shared neutral, circuit b, isolated ground A
- 1N** 10-wire duplex, separate neutrals, circuit 1 A
- 2N** 10-wire duplex, separate neutrals, circuit 2 A
- 1G** 10-wire duplex, separate neutrals, circuit 1, isolated ground A
- 2G** 10-wire duplex, separate neutrals, circuit 2, isolated ground A

Prices for Steps 1-2.

FW153.AN	\$39
BN	\$39
AG	\$39
BG	\$39
1N	\$39
2N	\$39
1G	\$39
2G	\$39

Step 3. Finish

BK black A + \$0

Controlled Receptacle, 4-Circuit, FW153M 20 Amp

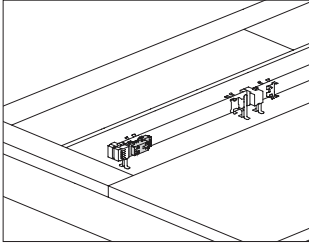

Product Information

Description
This receptacle is to be used for ASHRAE90.1 and Title 24 compliance. A controlled receptacle should be used for any receptacles that are under automated control by the energy management system. This receptacle snaps into an 8-wire, 4-circuit, shared neutral power harness or a 10-wire, 4-circuit, separate neutral power harness to provide power to equipment with a 20-amp standard plug head or cap. It also accepts 15-amp standard plug heads or caps. Package contains 1 receptacle. Receptacle is UL listed.

Notes

Avoid overloading circuit by ensuring total connected load does not exceed 16 amps. If 1 piece of equipment requires all available power, do not use receptacles second outlet or install additional receptacles on that circuit. In many cases, equipment requiring this receptacle will use all available power.

Dimensions

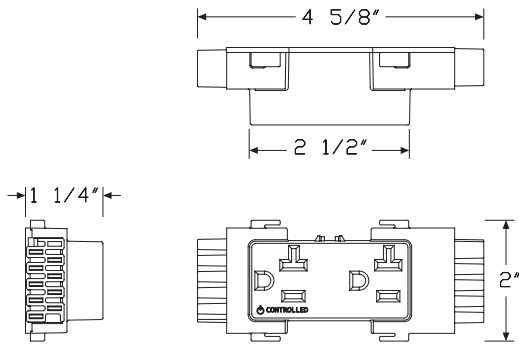

Specification Information

Step 1.

FW153M. A

Step 2. Type

- AN** 8-wire duplex, shared neutral, circuit a A
- BN** 8-wire duplex, shared neutral, circuit b A
- AG** 8-wire duplex, shared neutral, circuit a, isolated ground A
- BG** 8-wire duplex, shared neutral, circuit b, isolated ground A
- 1N** 10 wire, separate neutrals, circuit 1 A
- 2N** 10 wire, separate neutrals, circuit 2 A
- 1G** 10-wire duplex, separate neutrals, circuit 1, isolated ground A
- 2G** 10-wire duplex, separate neutrals, circuit 2, isolated ground A

Prices for Steps 1-2.

FW153M. AN	\$39
BN	\$39
AG	\$39
BG	\$39
1N	\$39
2N	\$39
1G	\$39
2G	\$39

Step 3. Finish

BK black A +\$0

Controlled Receptacle Decal
(12 per sheet)

G9999.

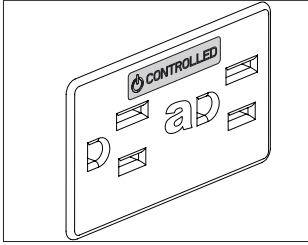

Product Information

Description

This decal is to be used for ASHRAE90.1 and Title 24 compliance. The decal is used to mark standard receptacles (new or existing) that are under automated control by the energy management system. 1 sheet includes 12 clear decals with white or black print.

Dimensions

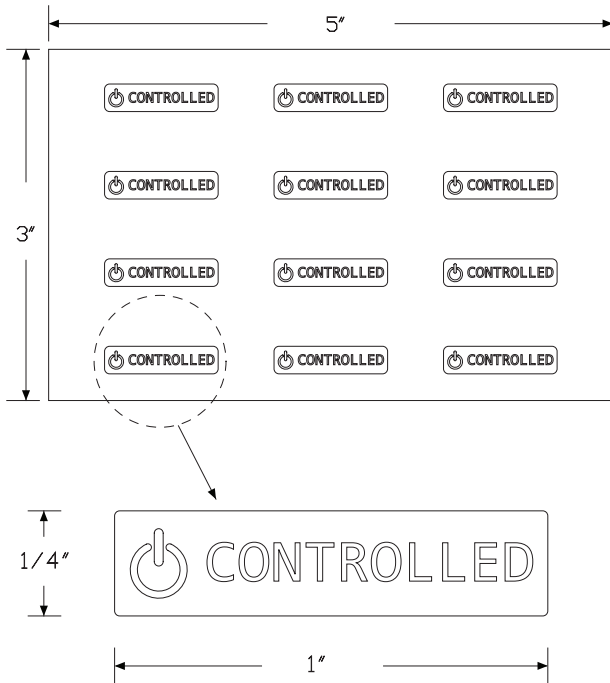

Specification Information

Step 1.

G9999. A

Step 2. Color

B black print A

W white print A

Prices for Steps 1-2.

G9999. B	\$8
W	\$8

Dual USB Charging Module, 2 Amp

FW15U.

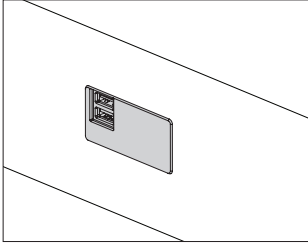

Canvas Office Landscape® Structure

Product Information

Description

This dual USB charging module locks into the power harness of the Canvas beam. Total output for both USB ports combined is 10 watts. The charging module is powered by circuit a for the 8-wire, and circuit 1 for the 10-wire.

Notes

The USB outlets can charge 2 devices at one time, rated 2 amps (10 watts) or less. It can charge 1 tablet and 1 phone, or 2 phones, at once. Maximum rating for both ports combined is 10 watts.

Dimensions

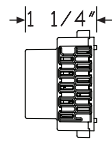
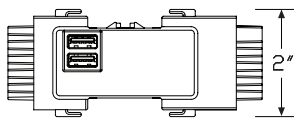
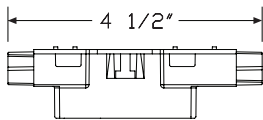

Specification Information

Step 1.

FW15U. A

Step 2. Configuration

08 8-wire, 4-circuit, shared neutral A

10 10-wire, 4-circuit, separate neutrals A

Prices for Steps 1-2.

FW15U.08	\$133
10	\$133

Step 3. Finish

8Q	folkstone grey	+\$0
91	white A	+\$0
98	studio white	+\$0
CL	cool grey neutral A	+\$0
G1	graphite A	+\$0
WL	sandstone	+\$0
WN	warm grey neutral A	+\$0

Rectangular Surface, End Position FWS10E

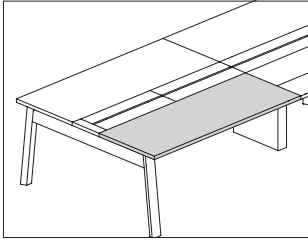

Product Information

Description

This surface is supported by the beam structure and support components. It is used at the end of a beam run and provides a 3" overhang at the end of the run. It has a laminate top and thermoplastic edge, laminate top with a thermoplastic backed plywood edge, or veneer top and edge. There is a 1/2" gap at the back of the surface for cord passage into the power/data trough.

Notes

Surface supports and attachment hardware are included with beam section (FW120, or FW121), ordered separately.

Surface width does not need to match beam width.

Actual depth of 30"-deep surface is 24". Actual depth of 36"-deep surface is 30". The actual surface depth accommodates the 6"-deep power/data access doors at the back edge of the surface to create the overall depth of 30" and 36".

Dimensions

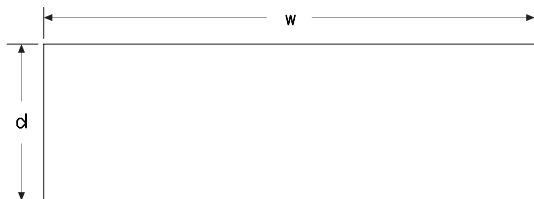

Specification Information

Step 1.

FWS10E. A

Step 2. Depth

30 30" deep A

36 36" deep A

Step 3. Width

51 51" wide A

57 57" wide A

63 63" wide A

69 69" wide A

75 75" wide A

81 81" wide A

87 87" wide A

93 93" wide A

99 99" wide A

Step 4. Surface Material

For 51" wide (51), 57" wide (57), 63" wide (63), 69" wide (69), 75" wide (75), 81" wide (81), 87" wide (87), or 93" wide (93)

L laminate top/thermoplastic edge A

W veneer A

U laminate top/universal edge A

For 99" wide (99)

L laminate top/thermoplastic edge A

Step 5. Power/Data Access

A for use with access door A

Prices for Steps 1-5.

		LA	WA	UA
FWS10E.	30 51	\$277	541	277
	57	\$324	620	324
	63	\$362	695	362
	69	\$402	774	402
	75	\$443	850	443
	81	\$483	920	483
	87	\$536	991	536
	93	\$551	1035	551
	99	\$574	—	—

Rectangular Surface, End Position

continued

Canvas Office Landscape® Surfaces

36 51	\$356	684	356
57	\$419	784	419
63	\$463	882	463
69	\$521	987	521
75	\$577	1089	577
81	\$616	1155	616
87	\$662	1221	662
93	\$699	1281	699
99	\$732	—	—

Step 6.

Top Finish

For laminate top/thermoplastic edge (L) or laminate top/universal edge (U)

8Q	folkstone grey	<input type="checkbox"/> A	+\$0
91	white	<input type="checkbox"/> A	+\$0
98	studio white	<input type="checkbox"/> A	+\$0
CL	cool grey neutral	<input type="checkbox"/> A	+\$0
HF	inner tone light	<input type="checkbox"/> A	+\$0
HT	inner tone	<input type="checkbox"/> A	+\$0
LU	soft white	<input type="checkbox"/> A	+\$0
WL	sandstone	<input type="checkbox"/> A	+\$0
WN	warm grey neutral	<input type="checkbox"/> A	+\$0
76	light brown walnut	<input type="checkbox"/> A	+\$0
HM	natural maple	<input type="checkbox"/> A	+\$0
HP	light anigre	<input type="checkbox"/> A	+\$0
HX	aged cherry	<input type="checkbox"/> A	+\$0
HY	walnut on cherry	<input type="checkbox"/> A	+\$0
LA	light ash	<input type="checkbox"/> A	+\$0
LBA	clear on ash	<input type="checkbox"/> A	+\$0
LBR	phantom ecru	<input type="checkbox"/> A	+\$0
LBS	phantom cocoa	<input type="checkbox"/> A	+\$0
LBU	medium matte walnut	<input type="checkbox"/> A	+\$0
LBV	warm grey teak	<input type="checkbox"/> A	+\$0
LBB	oak on ash	<input type="checkbox"/> A	+\$0
LBC	walnut on ash	<input type="checkbox"/> A	+\$0
LBD	dark brown walnut	<input type="checkbox"/> A	+\$0
LBE	medium red walnut	<input type="checkbox"/> A	+\$0
LBF	neutral twill	<input type="checkbox"/> A	+\$0
LBG	sarum twill	<input type="checkbox"/> A	+\$0
LBH	earthen twill	<input type="checkbox"/> A	+\$0
LBJ	graphite twill	<input type="checkbox"/> A	+\$0
LBQ	white twill	<input type="checkbox"/> A	+\$0
LBK	pewter mesh	<input type="checkbox"/> A	+\$0
LBL	steel mesh	<input type="checkbox"/> A	+\$0
LBM	crisp linen	<input type="checkbox"/> A	+\$0
LBN	classic linen	<input type="checkbox"/> A	+\$0
LBP	casual linen	<input type="checkbox"/> A	+\$0

Rectangular Surface, End Position

continued

Top/Edge Finish: Wood Veneer

For veneer (W)

2U	light brown walnut <input type="checkbox"/>	+\$85
40	dark brown walnut <input type="checkbox"/>	+\$85
ED	aged cherry <input type="checkbox"/>	+\$85
EK	medium red walnut <input type="checkbox"/>	+\$85
EW	medium matte walnut <input type="checkbox"/>	+\$85
ET	clear on ash <input type="checkbox"/>	+\$85
EU	oak on ash <input type="checkbox"/>	+\$85
EV	walnut on ash <input type="checkbox"/>	+\$85
UL	natural maple <input type="checkbox"/>	+\$85
UX	walnut on cherry <input type="checkbox"/>	+\$85

Step 7. Edge Finish

For laminate top/thermoplastic edge (L)

76	light brown walnut <input type="checkbox"/>	+\$0
8Q	folkstone grey <input type="checkbox"/>	+\$0
91	white <input type="checkbox"/>	+\$0
98	studio white <input type="checkbox"/>	+\$0
CL	cool grey neutral <input type="checkbox"/>	+\$0
LA	light ash <input type="checkbox"/>	+\$0
LBA	clear on ash <input type="checkbox"/>	+\$0
LBR	phantom ecru <input type="checkbox"/>	+\$0
LBS	phantom cocoa <input type="checkbox"/>	+\$0
LBU	medium matte walnut <input type="checkbox"/>	+\$0
LBV	warm grey teak <input type="checkbox"/>	+\$0
LBW	oak on ash <input type="checkbox"/>	+\$0
LBC	walnut on ash <input type="checkbox"/>	+\$0
LBD	dark brown walnut <input type="checkbox"/>	+\$0
LBE	medium red walnut <input type="checkbox"/>	+\$0
LBF	neutral twill <input type="checkbox"/>	+\$0
LBG	sarum twill <input type="checkbox"/>	+\$0
LBH	earthen twill <input type="checkbox"/>	+\$0
LBJ	graphite twill <input type="checkbox"/>	+\$0
LBK	pewter mesh <input type="checkbox"/>	+\$0
LBL	steel mesh <input type="checkbox"/>	+\$0
LBM	crisp linen <input type="checkbox"/>	+\$0
LBN	classic linen <input type="checkbox"/>	+\$0
LBP	casual linen <input type="checkbox"/>	+\$0
LBQ	white twill <input type="checkbox"/>	+\$0
WL	sandstone <input type="checkbox"/>	+\$0
WN	warm grey neutral <input type="checkbox"/>	+\$0
HF	inner tone light <input type="checkbox"/>	+\$0
HM	natural maple <input type="checkbox"/>	+\$0
HP	light anigre <input type="checkbox"/>	+\$0
HT	inner tone <input type="checkbox"/>	+\$0
HX	aged cherry <input type="checkbox"/>	+\$0
HY	walnut on cherry <input type="checkbox"/>	+\$0
LU	soft white <input type="checkbox"/>	+\$0

For laminate top/universal edge (U)

PLY	plywood edge <input type="checkbox"/>	+\$50
------------	---------------------------------------	-------

Rectangular Surface, Middle Position

FWS10M

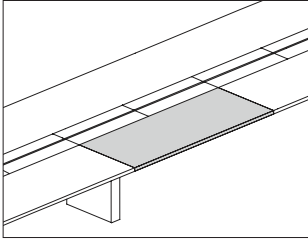

Canvas Office Landscape® Surfaces

Product Information

Description

This surface is supported by the beam structure and support components. It is used in a middle position of a beam run. It has a laminate top and thermoplastic edge, laminate top with a thermoplastic backed plywood edge, or veneer top and edge. There is a 1/2" gap at the back of the surface for cord passage into the power/data trough.

Notes

Surface supports and attachment hardware are included with beam section (FW120. or FW121.), ordered separately.

Surface width does not need to match beam width.

Actual depth of 30"-deep surface is 24". Actual depth of 36"-deep surface is 30". The actual surface depth accommodates the 6"-deep power/data access doors at the back edge of the surface to create a combined depth of 30" and 36".

Dimensions

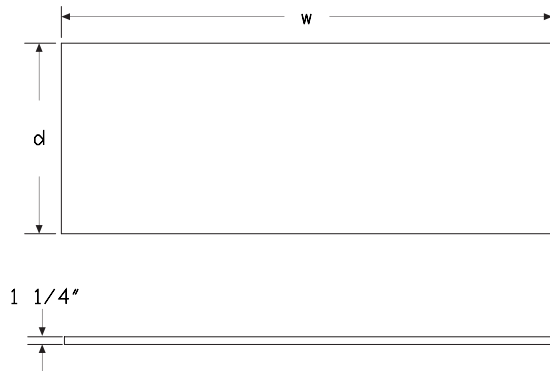

Specification Information

Step 1.

FWS10M. A

Step 2. Depth

30 30" deep A

36 36" deep A

Step 3. Width

48 48" wide A

54 54" wide A

60 60" wide A

66 66" wide A

72 72" wide A

78 78" wide A

84 84" wide A

90 90" wide A

96 96" wide A

Step 4. Surface Material

L laminate top/thermoplastic edge A

W veneer A

U laminate top/universal edge A

Step 5. Power/Data Access

A for use with access door A

Prices for Steps 1-5.

		LA	WA	UA
FWS10M.	30 48	\$267	531	267
	54	\$314	609	314
	60	\$351	685	351
	66	\$392	763	392
	72	\$433	840	433
	78	\$473	909	473
	84	\$526	981	526
	90	\$541	1025	541
	96	\$564	1054	564
	36 48	\$346	674	346
	54	\$408	774	408
	60	\$452	872	452
	66	\$510	977	510
	72	\$567	1079	567
	78	\$605	1145	605
	84	\$652	1211	652
	90	\$689	1270	689
	96	\$722	1330	722

Rectangular Surface, Middle Position *continued*

Step 6.

Top Finish

For laminate top/thermoplastic edge (L) or laminate top/universal edge (U)

8Q	folkstone grey <input type="checkbox"/>	+\$0
91	white <input type="checkbox"/>	+\$0
98	studio white <input type="checkbox"/>	+\$0
CL	cool grey neutral <input type="checkbox"/>	+\$0
HF	inner tone light <input type="checkbox"/>	+\$0
HT	inner tone <input type="checkbox"/>	+\$0
LU	soft white <input type="checkbox"/>	+\$0
WL	sandstone <input type="checkbox"/>	+\$0
WN	warm grey neutral <input type="checkbox"/>	+\$0
76	light brown walnut <input type="checkbox"/>	+\$0
HM	natural maple <input type="checkbox"/>	+\$0
HP	light anigre <input type="checkbox"/>	+\$0
HX	aged cherry <input type="checkbox"/>	+\$0
HY	walnut on cherry <input type="checkbox"/>	+\$0
LA	light ash <input type="checkbox"/>	+\$0
LBA	clear on ash <input type="checkbox"/>	+\$0
LBR	phantom ecru <input type="checkbox"/>	+\$0
LBS	phantom cocoa <input type="checkbox"/>	+\$0
LBU	medium matte walnut <input type="checkbox"/>	+\$0
LBV	warm grey teak <input type="checkbox"/>	+\$0
LBB	oak on ash <input type="checkbox"/>	+\$0
LBC	walnut on ash <input type="checkbox"/>	+\$0
LBD	dark brown walnut <input type="checkbox"/>	+\$0
LBE	medium red walnut <input type="checkbox"/>	+\$0
LBF	neutral twill <input type="checkbox"/>	+\$0
LBG	sarum twill <input type="checkbox"/>	+\$0
LBH	earthen twill <input type="checkbox"/>	+\$0
LBJ	graphite twill <input type="checkbox"/>	+\$0
LBQ	white twill <input type="checkbox"/>	+\$0
LBK	pewter mesh <input type="checkbox"/>	+\$0
LBL	steel mesh <input type="checkbox"/>	+\$0
LBM	crisp linen <input type="checkbox"/>	+\$0
LBN	classic linen <input type="checkbox"/>	+\$0
LBP	casual linen <input type="checkbox"/>	+\$0

Top/Edge Finish: Wood Veneer

For veneer (W)

2U	light brown walnut <input type="checkbox"/>	+\$85
40	dark brown walnut <input type="checkbox"/>	+\$85
ED	aged cherry <input type="checkbox"/>	+\$85
EK	medium red walnut <input type="checkbox"/>	+\$85
EW	medium matte walnut <input type="checkbox"/>	+\$85
ET	clear on ash <input type="checkbox"/>	+\$85
EU	oak on ash <input type="checkbox"/>	+\$85
EV	walnut on ash <input type="checkbox"/>	+\$85
UL	natural maple <input type="checkbox"/>	+\$85
UX	walnut on cherry <input type="checkbox"/>	+\$85

Rectangular Surface, Middle Position *continued*

Step 7. Edge Finish

For laminate top/thermoplastic edge (L)

76	light brown walnut <input type="checkbox"/> <input type="checkbox"/>	+\$0
8Q	folkstone grey <input type="checkbox"/>	+\$0
91	white <input type="checkbox"/>	+\$0
98	studio white <input type="checkbox"/>	+\$0
CL	cool grey neutral <input type="checkbox"/>	+\$0
LA	light ash <input type="checkbox"/>	+\$0
LBA	clear on ash <input type="checkbox"/>	+\$0
LBR	phantom ecru <input type="checkbox"/>	+\$0
LBS	phantom cocoa <input type="checkbox"/>	+\$0
LBU	medium matte walnut <input type="checkbox"/>	+\$0
LBV	warm grey teak <input type="checkbox"/>	+\$0
LBB	oak on ash <input type="checkbox"/>	+\$0
LBC	walnut on ash <input type="checkbox"/>	+\$0
LBD	dark brown walnut <input type="checkbox"/>	+\$0
LBE	medium red walnut <input type="checkbox"/>	+\$0
LBF	neutral twill <input type="checkbox"/>	+\$0
LBG	sarum twill <input type="checkbox"/>	+\$0
LBH	earthen twill <input type="checkbox"/>	+\$0
LBJ	graphite twill <input type="checkbox"/>	+\$0
LBK	pewter mesh <input type="checkbox"/>	+\$0
LBL	steel mesh <input type="checkbox"/>	+\$0
LBM	crisp linen <input type="checkbox"/>	+\$0
LBN	classic linen <input type="checkbox"/>	+\$0
LBP	casual linen <input type="checkbox"/>	+\$0
LBQ	white twill <input type="checkbox"/>	+\$0
WL	sandstone <input type="checkbox"/>	+\$0
WN	warm grey neutral <input type="checkbox"/>	+\$0
HF	inner tone light <input type="checkbox"/>	+\$0
HM	natural maple <input type="checkbox"/>	+\$0
HP	light anigre <input type="checkbox"/>	+\$0
HT	inner tone <input type="checkbox"/>	+\$0
HX	aged cherry <input type="checkbox"/>	+\$0
HY	walnut on cherry <input type="checkbox"/>	+\$0
LU	soft white <input type="checkbox"/>	+\$0

For laminate top/universal edge (U)

PLY	plywood edge <input type="checkbox"/>	+\$50
------------	---------------------------------------	-------

Rectangular Extension Surface

FWS37.

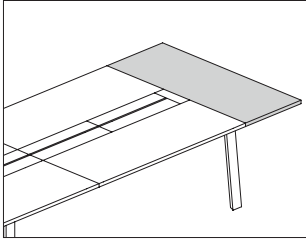

Product Information

Description

This surface can be attached to the end of a double-sided beam run to support collaboration and provide additional surface space. It has a laminate top and thermoplastic edge, laminate top with a thermoplastic backed plywood edge, or veneer top and edge.

Surface supports and attachment hardware are included.

Dimensions



1 1/4"

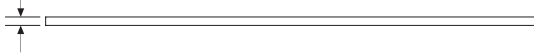

Specification Information

Step 1.

FWS37.

Step 2. Depth

24 24" deep

Step 3. Width

60 60" wide

72 72" wide

Step 4. Surface Material

L laminate top/thermoplastic edge

W veneer

U laminate top/universal edge

Prices for Steps 1-4.

	L	W	U
FWS37.24 60	\$657	991	657
72	\$739	1146	739

Step 5.

Top Finish

For laminate top/thermoplastic edge (L) or laminate top/universal edge (U)

28 canyon <input type="checkbox"/>	+\$0
29 misted <input type="checkbox"/>	+\$0
38 twilight <input type="checkbox"/>	+\$0
39 desert <input type="checkbox"/>	+\$0
1X vanilla <input type="checkbox"/>	+\$0
2X wheat <input type="checkbox"/>	+\$0
3X celery <input type="checkbox"/>	+\$0
4X coriander <input type="checkbox"/>	+\$0
5X chamomile <input type="checkbox"/>	+\$0
6X cinnamon <input type="checkbox"/>	+\$0
7X cardamom <input type="checkbox"/>	+\$0
8X kale <input type="checkbox"/>	+\$0
8Q folkstone grey <input type="checkbox"/>	+\$0
91 white <input type="checkbox"/>	+\$0
98 studio white <input type="checkbox"/>	+\$0
CL cool grey neutral <input type="checkbox"/>	+\$0
HF inner tone light <input type="checkbox"/>	+\$0
HT inner tone <input type="checkbox"/>	+\$0
LG light grey (discontinuing) <input type="checkbox"/>	+\$0
LT light tone <input type="checkbox"/>	+\$0
LU soft white <input type="checkbox"/>	+\$0

Rectangular Extension Surface

continued

MT	medium tone <input type="checkbox"/>	+\$0
WL	sandstone <input type="checkbox"/>	+\$0
WN	warm grey neutral <input type="checkbox"/>	+\$0
X1	chalk white <input type="checkbox"/>	+\$0
J4	frosted light grey <input type="checkbox"/>	+\$0
76	light brown walnut <input type="checkbox"/>	+\$0
HM	natural maple <input type="checkbox"/>	+\$0
HP	light anigre <input type="checkbox"/>	+\$0
HX	aged cherry <input type="checkbox"/>	+\$0
HY	walnut on cherry <input type="checkbox"/>	+\$0
LA	light ash <input type="checkbox"/>	+\$0
LBA	clear on ash <input type="checkbox"/>	+\$0
LBR	phantom ecru <input type="checkbox"/>	+\$0
LBS	phantom cocoa <input type="checkbox"/>	+\$0
LBU	medium matte walnut <input type="checkbox"/>	+\$0
LBV	warm grey teak <input type="checkbox"/>	+\$0
LBB	oak on ash <input type="checkbox"/>	+\$0
LBC	walnut on ash <input type="checkbox"/>	+\$0
LBD	dark brown walnut <input type="checkbox"/>	+\$0
LBE	medium red walnut <input type="checkbox"/>	+\$0
LM	mahogany <input type="checkbox"/>	+\$0
OG	honey maple <input type="checkbox"/>	+\$0
LBF	neutral twill <input type="checkbox"/>	+\$0
LBG	sarum twill <input type="checkbox"/>	+\$0
LBH	earthen twill <input type="checkbox"/>	+\$0
LBJ	graphite twill <input type="checkbox"/>	+\$0
LBQ	white twill <input type="checkbox"/>	+\$0
LBK	pewter mesh <input type="checkbox"/>	+\$0
LBL	steel mesh <input type="checkbox"/>	+\$0
LBM	crisp linen <input type="checkbox"/>	+\$0
LBN	classic linen <input type="checkbox"/>	+\$0
LBP	casual linen <input type="checkbox"/>	+\$0

Top/Edge Finish: Wood Veneer

For veneer (W)

2U	light brown walnut <input type="checkbox"/>	+\$85
40	dark brown walnut <input type="checkbox"/>	+\$85
ED	aged cherry <input type="checkbox"/>	+\$85
EK	medium red walnut <input type="checkbox"/>	+\$85
EW	medium matte walnut <input type="checkbox"/>	+\$85
ET	clear on ash <input type="checkbox"/>	+\$85
EU	oak on ash <input type="checkbox"/>	+\$85
EV	walnut on ash <input type="checkbox"/>	+\$85
UL	natural maple <input type="checkbox"/>	+\$85
UX	walnut on cherry <input type="checkbox"/>	+\$85

Step 6. Edge Finish

For laminate top/thermoplastic edge (L)

76	light brown walnut <input type="checkbox"/>	+\$0
8Q	folkstone grey <input type="checkbox"/>	+\$0
91	white <input type="checkbox"/>	+\$0
98	studio white <input type="checkbox"/>	+\$0
CL	cool grey neutral <input type="checkbox"/>	+\$0
LA	light ash <input type="checkbox"/>	+\$0
LBA	clear on ash <input type="checkbox"/>	+\$0
LBR	phantom ecru <input type="checkbox"/>	+\$0
LBS	phantom cocoa <input type="checkbox"/>	+\$0
LBU	medium matte walnut <input type="checkbox"/>	+\$0
LBV	warm grey teak <input type="checkbox"/>	+\$0
LBB	oak on ash <input type="checkbox"/>	+\$0
LBC	walnut on ash <input type="checkbox"/>	+\$0
LBD	dark brown walnut <input type="checkbox"/>	+\$0
LBE	medium red walnut <input type="checkbox"/>	+\$0
LBF	neutral twill <input type="checkbox"/>	+\$0
LBG	sarum twill <input type="checkbox"/>	+\$0
LBH	earthen twill <input type="checkbox"/>	+\$0
LBJ	graphite twill <input type="checkbox"/>	+\$0
LBK	pewter mesh <input type="checkbox"/>	+\$0
LBL	steel mesh <input type="checkbox"/>	+\$0
LBM	crisp linen <input type="checkbox"/>	+\$0
LBN	classic linen <input type="checkbox"/>	+\$0
LBP	casual linen <input type="checkbox"/>	+\$0
LBQ	white twill <input type="checkbox"/>	+\$0
WL	sandstone <input type="checkbox"/>	+\$0
WN	warm grey neutral <input type="checkbox"/>	+\$0
HF	inner tone light <input type="checkbox"/>	+\$0
HM	natural maple <input type="checkbox"/>	+\$0
HP	light anigre <input type="checkbox"/>	+\$0
HT	inner tone <input type="checkbox"/>	+\$0
HX	aged cherry <input type="checkbox"/>	+\$0
HY	walnut on cherry <input type="checkbox"/>	+\$0
LU	soft white <input type="checkbox"/>	+\$0
X1	chalk white <input type="checkbox"/>	+\$0
28	canyon <input type="checkbox"/>	+\$0
29	misted <input type="checkbox"/>	+\$0
BU	black umber <input type="checkbox"/>	+\$0
MT	medium tone <input type="checkbox"/>	+\$0
LT	light tone <input type="checkbox"/>	+\$0
38	twilight <input type="checkbox"/>	+\$0
39	desert <input type="checkbox"/>	+\$0
LG	light grey (discontinuing) <input type="checkbox"/>	+\$0
WA	wheat <input type="checkbox"/>	+\$0

Rectangular Extension Surface

continued

CO	chamomile <input type="checkbox"/>	+\$0
CM	cinnamon <input type="checkbox"/>	+\$0
N3	cool grey <input type="checkbox"/>	+\$0
SG	slate grey <input type="checkbox"/>	+\$0
JB	millwork cherry <input type="checkbox"/>	+\$0
G2	graphite satin <input type="checkbox"/>	+\$0
9V	tapestry beige <input type="checkbox"/>	+\$0
8Z	neutral grey <input type="checkbox"/>	+\$0
OG	honey maple <input type="checkbox"/>	+\$0
LM	mahogany <input type="checkbox"/>	+\$0

For laminate top/universal edge (U)

PLY	plywood edge <input type="checkbox"/>	+\$50
------------	---------------------------------------	-------

Pari Screen, Beam-Attached

FW415.

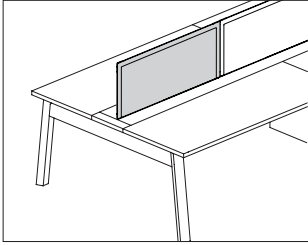

Canvas Office Landscape® Screens

Product Information

Description

This tackable fabric screen attaches into the accessory channel of a single- or double-sided beam section to provide visual privacy with a tackable surface. Bayonets attach into the center channel and extend up for attachment. Attachment hardware included.

Notes

Screen has concealed attachment method and can attach anywhere along the length of beam section or can span multiple beam sections within a run.

To align screens in a run and fill light gap between screens, order connection hardware (FW416.) separately.

Screen accepts Customer's Own Material (COM). Yardage is estimated for nondirectional 54"-wide fabrics.

For vertical fabric direction (T):

Height—Yardage

14—1.17

18—1.43

For horizontal fabric direction (R):

Width—Yardage

30—1.14

36—1.32

48—1.71

60—2.07

72—2.46

For information on multiple quantities or directional fabrics, contact COM Department. See Order Information in Appendices.

Dimensions

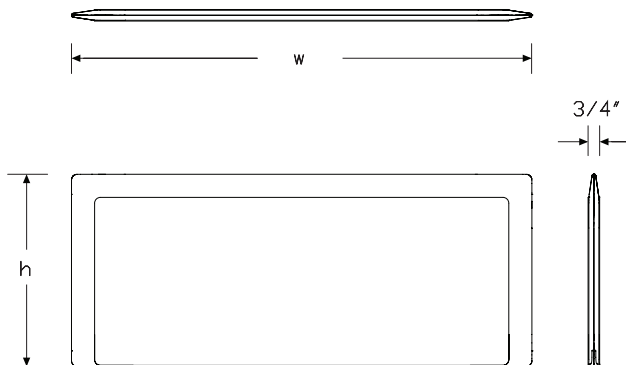

Specification Information

Step 1.

FW415. A

Step 2. Height

14 13½" high A

18 17½" high A

Step 3. Width

30 30" wide A

36 36" wide A

48 48" wide A

60 60" wide A

72 72" wide A

Step 4. Surface Material

For 30" wide (30), 36" wide (36), or 48" wide (48)

R tackable fabric, horizontal A

T tackable fabric A

For 60" wide (60) or 72" wide (72)

R tackable fabric, horizontal A

Prices for Steps 1-4.

		R	T
FW415. 14	30	\$822	822
	36	\$827	827
	48	\$862	862
	60	\$873	—
	72	\$939	—
18	30	\$842	842
	36	\$852	852
	48	\$918	918
	60	\$939	—
	72	\$1102	—

Step 5. Fabric

For 30" wide (30), 36" wide (36), or 48" wide (48)

Price Category 1	+\$0
Price Category 2	+\$18
Price Category 3	+\$42
Price Category 4	+\$73

Pari Screen, Beam-Attached

continued

For 60" wide (60) or 72" wide (72)

Price Category 1	+\$0
Price Category 2	+\$31
Price Category 3	+\$73
Price Category 4	+\$127
Price Category E	+\$195

Connection Hardware, Pari
Screen, Beam-Attached

FW416.

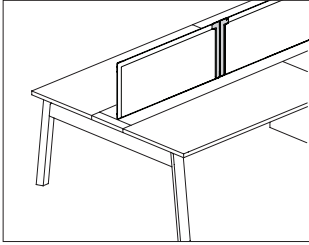

Product Information

Description
This steel piece slides between 2 beam-attached Pari screens to provide alignment and to fill the light gap at the bottom of the screen connection point. Package of 3.

Dimensions

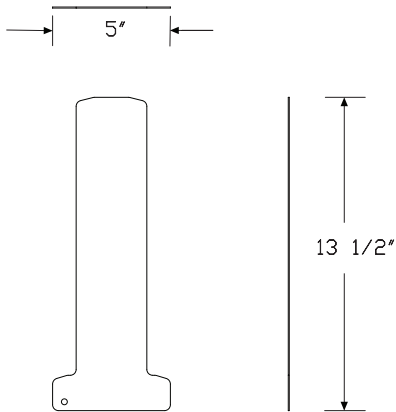

Specification Information

Step 1.

FW416. [A]

Step 2. Configuration

1 spacer [A]

Step 3. Height

42 42" high [A]

46 46" high [A]

Prices for Steps 1-3.

	42	46
FW416. 1	\$77	82

Step 4. Finish

MS metallic silver [A] + \$0

Flat Edge Screen, Beam Attached FW417.

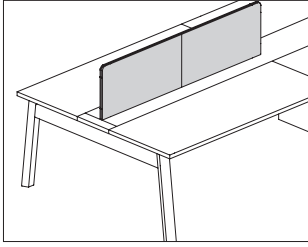

Product Information

Description

This tackable fabric screen attaches into the accessory channel of a single- or double-sided beam section to provide visual privacy with a tackable surface. Bayonets attach into the center channel and extend up for attachment. Attachment hardware included.

Notes

Screen has concealed attachment method and can attach anywhere along the length of beam section or can span multiple beam sections within a run.

To align screens in a run and fill light gap between screens, order connection hardware (FW416.) separately.

Screen accepts Customer's Own Material (COM). Yardage is estimated for nondirectional 54"-wide fabrics.

For vertical fabric direction (T):

Height—Yardage

14—1.17

18—1.43

For horizontal fabric direction (R):

Width—Yardage

30—1.14

36—1.32

48—1.71

60—2.07

72—2.46

For information on multiple quantities or directional fabrics, contact COM Department. See Order Information in Appendices.

Dimensions

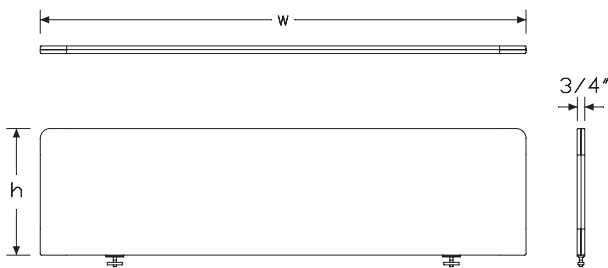

Specification Information

Step 1.

FW417.

Step 2. Height

14 13¹/₂" high

18 17¹/₂" high

Step 3. Width

30 30" wide

36 36" wide

48 48" wide

60 60" wide

72 72" wide

Step 4. Surface Material

For 30" wide (30), 36" wide (36), or 48" wide (48)

R tackable fabric, horizontal

T tackable fabric

For 60" wide (60) or 72" wide (72)

R tackable fabric, horizontal

Prices for Steps 1-4.

		R	T
FW417. 14 30	30	\$405	405
	36	\$429	429
	48	\$453	453
	60	\$550	—
	72	\$620	—
18 30	30	\$425	425
	36	\$454	454
	48	\$508	508
	60	\$615	—
	72	\$780	—

Step 5. Fabric

	30	36	48	60	72
Price Category 1	+\$0	0	0	0	0
Price Category 2	+\$18	18	18	31	31
Price Category 3	+\$42	42	42	73	73
Price Category 4	+\$73	73	73	127	127
Price Category E	+\$0	0	0	0	0

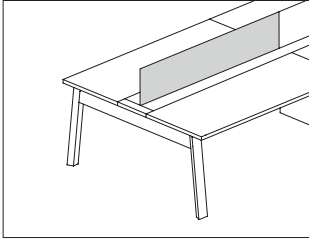

Product Information

Description
 This glass screen attaches into the accessory channel of a single- or double-sided beam section to provide visual privacy. It has a concealed attachment method and can attach anywhere along the length of the beam section, or can span multiple beam sections within a run. Attachment hardware is included.

Notes
 For no infill for customers own insert (NN), custom insert can be 0.221" - 0.26" thick and up to 17½" high. Recommended materials are glass, acrylic, laminate, wood or materials that will remain straight over time.

Dimensions

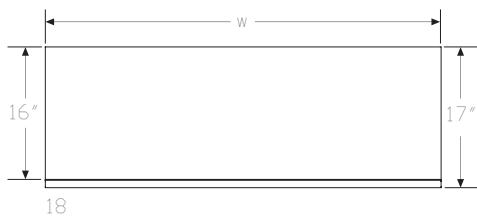
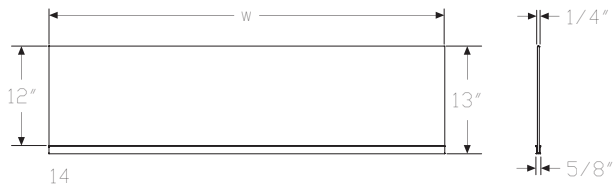

Specification Information

Step 1.

FW410. [A]

Step 2. Height

- 14** 13½" high [A]
- 18** 17½" high [A]

Step 3. Width

- 30** 30" wide [A]
- 36** 36" wide [A]
- 48** 48" wide [A]
- 60** 60" wide [A]
- 72** 72" wide [A]
- 96** 96" wide [A]

Step 4. Surface Finish

- TR** clear [A]
- 5A** opal etched [A]
- NN** no glass- for customer's own glass [A]

Prices for Steps 1-4.

		TR	5A	NN
FW410. 14	30	\$324	444	199
	36	\$350	503	215
	48	\$415	620	240
	60	\$480	771	271
	72	\$536	883	301
	96	\$648	1082	332
18	30	\$346	520	199
	36	\$378	589	215
	48	\$451	725	240
	60	\$536	884	271
	72	\$592	1029	301
	96	\$719	1287	332

Laminate Screen, Beam Attached FW419.

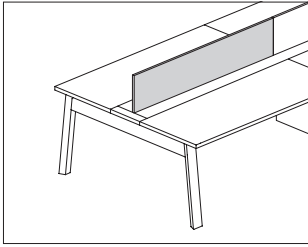

Product Information

Description

This laminate screen attaches into the accessory channel of a single- or double-sided beam section to provide visual privacy. Bayonets attach into the center channel and extend up for attachment. Attachment hardware included.

Notes

Screen has concealed attachment method and can attach anywhere along the length of beam section or can span multiple beam sections within a run.
 To align screens in a run, order connection hardware (Y1121.) separately.

Dimensions

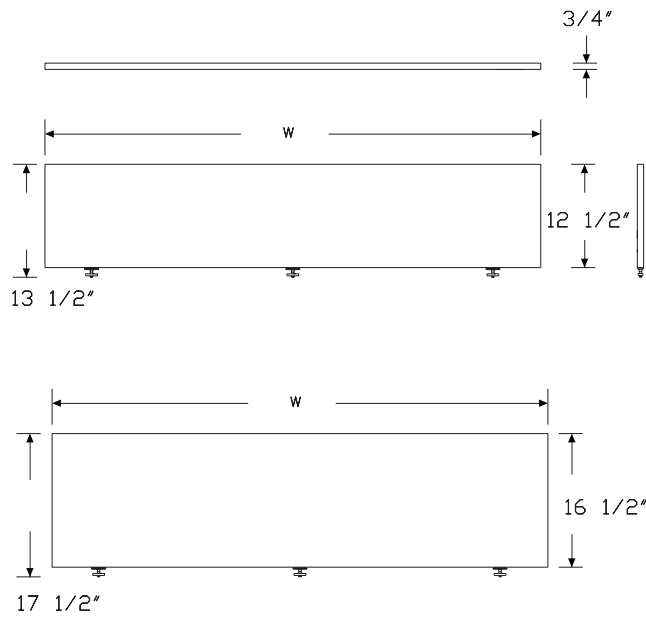

Specification Information

Step 1.

FW419.

Step 2. Height

- 14** 13 1/2" high
- 18** 17 1/2" high

Step 3. Width

- 30** 30" wide
- 36** 36" wide
- 48** 48" wide
- 60** 60" wide
- 72** 72" wide

Step 4. Surface Material

- L** laminate
- U** laminate/universal edge

Prices for Steps 1-4.

	L	U
FW419. 14 30	\$325	325
36	\$355	355
48	\$385	385
60	\$415	415
72	\$446	446
18 30	\$378	378
36	\$408	408
48	\$438	438
60	\$468	468
72	\$549	549

Step 5. Grain Direction

For 30" wide (30), 36" wide (36), 48" wide (48), or 60" wide (60)

- VTG** vertical grain +\$0
- HRG** horizontal grain +\$0

For 72" wide (72)

- HRG** horizontal grain +\$0

Laminate Screen, Beam Attached

continued

Canvas Office Landscape® Screens

Step 6. Surface Finish		
76	light brown walnut	+\$0
8Q	folkstone grey	+\$0
91	white	+\$0
98	studio white	+\$0
CL	cool grey neutral	+\$0
HM	natural maple	+\$0
HP	light anigre	+\$0
HX	aged cherry	+\$0
HY	walnut on cherry	+\$0
LA	light ash	+\$0
LBA	clear on ash	+\$0
LBB	oak on ash	+\$0
LBC	walnut on ash	+\$0
LBD	dark brown walnut	+\$0
LBE	medium red walnut	+\$0
LBF	neutral twill	+\$0
LBG	sarum twill	+\$0
LBH	earthen twill	+\$0
LBJ	graphite twill	+\$0
LBK	pewter mesh	+\$0
LBL	steel mesh	+\$0
LBM	crisp linen	+\$0
LBN	classic linen	+\$0
LBP	casual linen	+\$0
LBQ	white twill	+\$0
LBR	phantom ecru	+\$0
LBS	phantom cocoa	+\$0
LBU	medium matte walnut	+\$0
LBV	warm grey teak	+\$0
LU	soft white	+\$0
WL	sandstone	+\$0
WN	warm grey neutral	+\$0

HY	walnut on cherry	+\$0
LA	light ash	+\$0
LBA	clear on ash	+\$0
LBR	phantom ecru	+\$0
LBS	phantom cocoa	+\$0
LBU	medium matte walnut	+\$0
LBV	warm grey teak	+\$0
LBB	oak on ash	+\$0
LBC	walnut on ash	+\$0
LBD	dark brown walnut	+\$0
LBE	medium red walnut	+\$0
LBF	neutral twill	+\$0
LBG	sarum twill	+\$0
LBH	earthen twill	+\$0
LBJ	graphite twill	+\$0
LBK	pewter mesh	+\$0
LBL	steel mesh	+\$0
LBM	crisp linen	+\$0
LBN	classic linen	+\$0
LBP	casual linen	+\$0
LBQ	white twill	+\$0
LU	soft white	+\$0
MT	medium tone	+\$0
WL	sandstone	+\$0
WN	warm grey neutral	+\$0

For laminate/universal edge (U)

PLY	plywood edge	+\$50
------------	--------------	-------

Step 7. Edge Finish

For laminate (L)

76	light brown walnut	+\$0
8Q	folkstone grey	+\$0
91	white	+\$0
98	studio white	+\$0
BU	black umber	+\$0
CL	cool grey neutral	+\$0
HF	inner tone light	+\$0
HM	natural maple	+\$0
HP	light anigre	+\$0
HX	aged cherry	+\$0

Index by Product Name

Canvas Office Landscape® Beam-Based	
Beam-Attached Screen, Glass	page(s) 38
Beam Section, Double-Sided	5
Beam Section, Single-Sided	7
Connection Hardware, Pari Screen, Beam-Attached	36
Controlled Receptacle, 4-Circuit, 15 Amp	20
Controlled Receptacle, 4-Circuit, 20 Amp	22
Controlled Receptacle Decal (12 per sheet)	23
Dual USB Charging Module, 2 Amp	24
End Support, Open	11
Flat Edge Screen, Beam Attached	37
Floor Power Entry Cover	18
Harness-to-Harness Jumper	15
In-Line Beam Connector	9
Laminate Screen, Beam Attached	39
Mid-Run Support, Closed	13
Mid-Run Support, Open	12
Pari Screen, Beam-Attached	34
Power Entry, Internal Direct Connect	16
Power Entry, New York City	17
Power Harness	14
Receptacle, 4-Circuit, 15 Amp	19
Receptacle, 4-Circuit, 20 Amp	21
Rectangular Extension Surface	31
Rectangular Surface, End Position	25
Rectangular Surface, Middle Position	28
Trim Strip, Beam Accessory Channel	10



Index by Product Number

FW15U. Dual USB Charging Module, 2 Amp	page(s) 24
FW120. Beam Section, Double-Sided	5
FW121. Beam Section, Single-Sided	7
FW123. In-Line Beam Connector	9
FW124. Trim Strip, Beam Accessory Channel	10
FW130. End Support, Open	11
FW132. Mid-Run Support, Closed	13
FW133. Mid-Run Support, Open	12
FW140. Power Entry, Internal Direct Connect	16
FW141. Power Entry, New York City	17
FW143. Floor Power Entry Cover	18
FW150. Power Harness	14
FW151. Harness-to-Harness Jumper	15
FW152M Controlled Receptacle, 4-Circuit, 15 Amp	20
FW152. Receptacle, 4-Circuit, 15 Amp	19
FW153M Controlled Receptacle, 4-Circuit, 20 Amp	22
FW153. Receptacle, 4-Circuit, 20 Amp	21
FW410. Beam-Attached Screen, Glass	38
FW415. Pari Screen, Beam-Attached	34
FW416. Connection Hardware, Pari Screen, Beam-Attached	36
FW417. Flat Edge Screen, Beam Attached	37
FW419. Laminate Screen, Beam Attached	39
FWS10E Rectangular Surface, End Position	25
FWS10M Rectangular Surface, Middle Position	28
FWS37. Rectangular Extension Surface	31
G9999. Controlled Receptacle Decal (12 per sheet)	23



20-Day or Less/Assigned Lead-Time Order Information

20-Day or Less and Assigned Lead-Time Programs

20-day or less and assigned lead-time products are designed for established Herman Miller dealers with pre-approved credit.

Products are distributed from multiple manufacturing facilities across the United States. All products and options not designated by an Assigned Lead-Time icon **A** will ship in 20 business days or less after being acknowledged by Herman Miller. Products and options designated by an **A** are on the assigned lead-time program and will ship in 20 days, less than 20 days, or more than 20 days from order acknowledgement.

Ordering Procedure

Please place orders through Order Manager. If this is not available to you, place orders through mail or fax. Verbal purchase orders will not be accepted.

Order Entry fax number for Passage®, 5000 Series, and Meridian® Filing and Storage: (616) 846 9236.

Order Entry fax number for all other products:
(616) 654 3085.

For more information, contact your Customer Care representative at:
(866) 854 3048 EXT 3400.

Shipments and Delivery

Per Herman Miller Terms and Conditions.

Changes and Cancellation

Per Herman Miller Terms and Conditions.



Keyed-Alike Information

Keyed-Alike Locks

All components with locks may be specified keyed alike. Products with keyed-alike locks will be shipped with lock chassis installed.

Installation of lock cylinders will be on-site according to instructions provided. Herman Miller, Inc., will not be responsible for lock cylinder installation.

When specifying product keyed-alike, include separate lines on your order for the lock cylinders.

For Action Office®, Ethospace®, Passage®, Quadrant®, Resolve®, and Supplemental products, list cylinder part number and key number (232092-XXX); select a key number (or numbers) between 226 and 427, excluding numbers 408 and 412.

The following products require a different lock cylinder part number. Specify UKY001-XXX for these products only; select a key number (or numbers) between 226 and 427, excluding numbers 408 and 412.

- A3013.
- A3053.
- G5180.
- G5181.
- G5280.

The keys provided in 232092-XXX and UKY001-XXX kits work with either cylinder type, provided the key numbers match.

For Tu® Storage, Canvas Office Landscape®, 5000 Series, and Meridian® Storage, see the following charts.

Keyed-alike locks are field installed.

To order keyed-alike locks for Action Office® Series 1 and 2 door panels, please contact Customer Care.

A master key can be used to open any lock on an attached or freestanding component. In addition, a removal key or lock change tool is required to remove lock plugs. Customers interested in ordering master keys, removal keys, or lock change tools should contact Customer Care.

For Canvas overhead and lower storage units, specify as follows:

Specification Code	Part Number	Color	Lock Series
KA	1B2JK7-XXX ¹	chrome	UM series 226-427

For Canvas Metal Storage, Meridian Storage, Tu Storage, and 5000 Series desk components with pedestals, specify as follows:

Specification Code	Key Number	Color	Lock Series
KA	232092-XXX ¹	black	UM series 226-427
KA	1B2JK7-XXX ¹	chrome	UM series 226-427

For 5000 Series flipper door unit with bezel or credenza storage cabinet with bezel, specify as follows:

Specification Code	Key Number	Color	Lock Series
KA	232092-XXX ¹	black	UM series 226-427

Key Number:

XXX¹ = a key number between 226 and 427 (excluding 408 and 412)

Vary Easy Program

Program Overview

Vary Easy is a program designed to help dealers specify standard products with a larger breadth of options. For example, depending on the type of product being specified, choices include additional size, finish, edge types, and cable management features. Vary Easy 3D, specIT, and third-party text-based specification packages support the Vary Easy program. Vary Easy 3D enables designers to create a 3D image, CAD symbols, and a price book page. A Vary Easy product number is assigned for each product as the user selects specific options. Once the product is completely specified, the order can be submitted via Kiosk's Order Manager or a dealer's business system.

Accessing and Specifying Vary Easy

To view the full product vocabulary, go to the Vary Easy Product Offering on Kiosk. To specify Vary Easy, go to the Vary Easy 3D website on Kiosk, specIT, or your third-party text-based specification package.

Once you've made your product line selection, continue to follow through each option and enter the specific options that represent the product you need. When the product is fully specified, Vary Easy will generate an orderable product number and instantly calculate a price.

Note: Failure to completely specify a product will cause a delay in order acknowledgements. Be sure to make a selection for all options offered.

The acknowledgement process for Vary Easy products is the same as for any standard order. Vary Easy products ship with a standardized lead time and are competitively priced.

For more information, contact your Customer Care Line at (866) 854 3048 EXT 3400.

Stain-to-Match Program

Stain-to-Match Program

Program Overview

The Stain-to-Match program gives you the option of using veneer finishes that are not listed in the standard offering. The program allows Herman Miller to match a customer's existing recut or natural veneer, or create a new finish that is unique to an installation.

Specific information on approval, ordering, pricing, and warranty for the Stain-to-Match program is listed below. Questions and requests for assistance may be directed to Herman Miller Options at:

(800) 654 3910

Ordering Products with Stain-to-Match Veneers

1. Fill out the Options Stain-to-Match Request Form and send along with a color sample (2" x 3" minimum) to the Herman Miller Options Applications Team at the address provided on the form. The form can be found on Omni.
2. Within 7-10 working days, Herman Miller Options will send a sample of the color-matched stain on Herman Miller veneer to the requester for the customer's signed approval.
3. If the sample meets the customer's approval, sign the reverse side of the sample, scan and email the approval to:
options@hermanmiller.com.
4. After the stain has been approved, a formal quotation with special number and pricing can be provided, or the product can be specified through the Vary Easy program, if available. Work with the Options team on final product needs and how to specify.
5. A purchase order can then be placed.

Stain-to-Match Warranty

Herman Miller warrants its products to be free from defects in craftsmanship from the date of delivery for the applicable warranty period. Herman Miller is responsible for the physical properties of the veneers available through the Stain-to-Match program, which include:

- STA: Stain-to-Match on Recut Ash
- STB: Stain-to-Match on Beech
- STC: Stain-to-Match on Cherry
- STD: Stain-to-Match on Oak
- STK: Stain-to-Match on Reltech Anigre (Geiger)
- STM: Stain-to-Match on Recut Mahogany
- STP: Stain-to-Match on Maple
- STU: Stain-to-Match on Walnut (Geiger)

See your specification tool for product specific finish offering limitations.





Canvas Office Landscape® Connectors and Covers Matrix

Use the following matrix to confirm your connector, cover, and top cap selection based on the frame heights specified. This matrix represents a subset of the possible frame and connector applications and shows the correct connector, connector cover, and top cap to specify.

For additional applications and information, see the Canvas Office Landscape® Planning Guide.

Legend

Frames

-  Same Height/Tallest
-  11" Drop in Height
-  22" Drop in Height

Connectors

35" and 46" High Frames



 .46

57", 68" and 79" High Frames

 .57

Covers

One Side

-  .1 + Required Height
-  (Shown When 2 are Required)

Two Sides

 .2 + Required Height

Three Sides

 .3 + Required Height

Top Caps

 .1A

 .2A

 .2B

 .3A

 .4A

2-Way, Equal-Height Frames

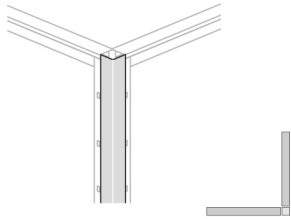

Frames 35/35



Frames 46/46



Frames 57/57



Frames 68/68



Frames 79/79



2-Way, 1 Frame 11" Lower

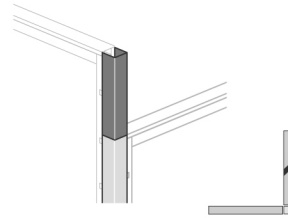

Frames 46/35

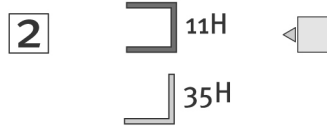

Frames 57/46

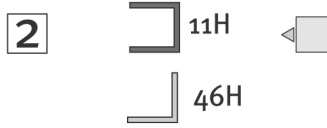

Frames 68/57

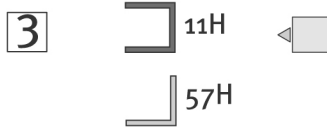

Frames 79/68

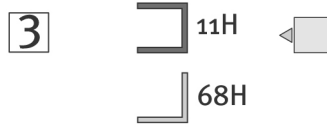

2-Way, 1 Frame 22" Lower

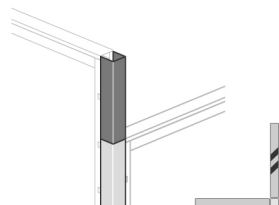

Frames 57/35

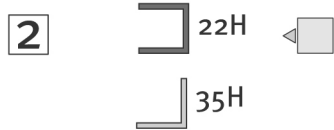

Frames 68/46

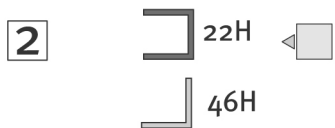

Frames 79/57

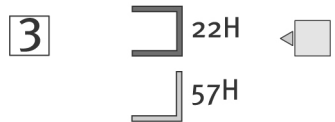

3-Way, Equal-Height Frames

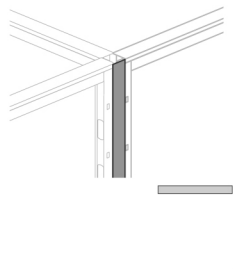

Frames 35/35/35

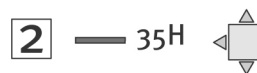

Frames 46/46/46

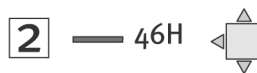

Frames 57/57/57

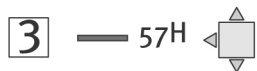

Frames 68/68/68

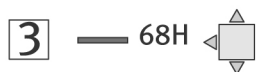

Frames 79/79/79

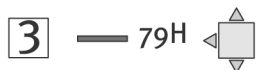

Canvas Office Landscape® Connectors and Covers Matrix *continued*

3-Way, 1 Frame 11" Higher

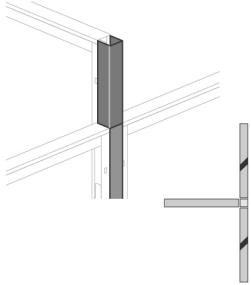

Frames 35/46/35

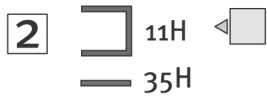

Frames 46/57/46



Frames 57/68/57

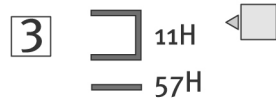

Frames 68/79/68



3-Way, 1 Frame 22" Higher

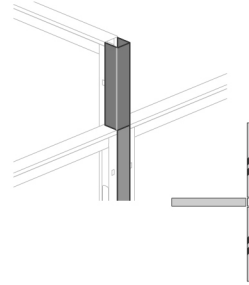

Frames 35/57/35



Frames 46/68/46



Frames 57/79/57

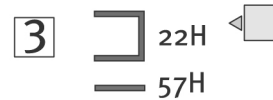

4-Way, Equal-Height Frames

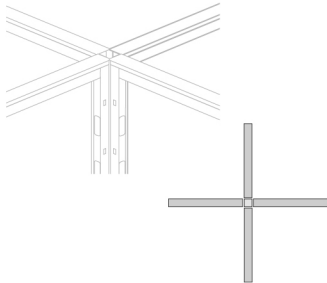

Frames 35

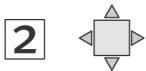

Frames 46

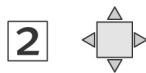

Frames 57

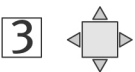

Frames 68

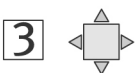

Frames 79

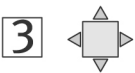

4-Way, 2 180° Equal-Height Frames, 2 180° Frames
11" Lower

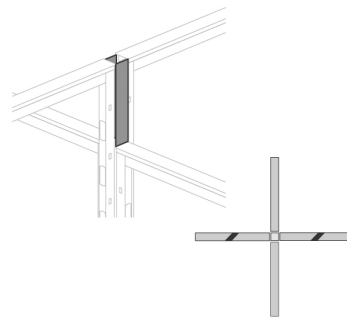

Frames 46/35/46/35

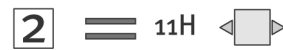

Frames 57/46/57/46

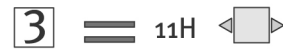

Frames 68/57/68/57

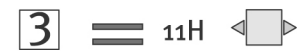

Frames 79/68/79/68

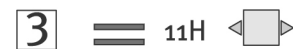

Canvas Office Landscape® Connectors and Covers Matrix *continued*

Appendix: Canvas Office Landscape® Connectors and Covers Matrix

4-Way, 2 180° Equal-Height Frames, 2 180° Frames 22" Lower

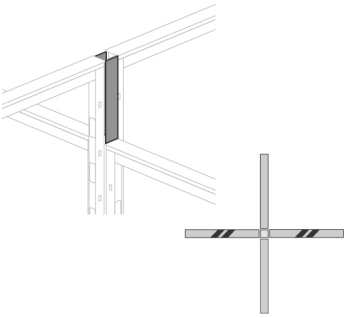

Frames 57/35/57/35

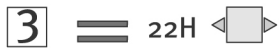

Frames 68/46/68/46

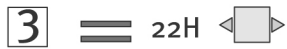

Frames 79/57/79/57

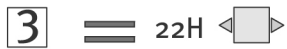

4-Way, 2 90° Frames 11" Lower, 1 Frame 22" Lower

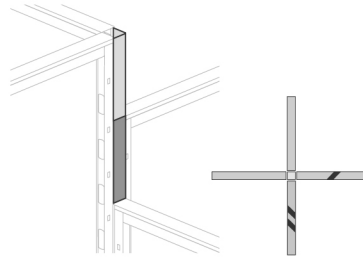

Frames 57/57/46/35

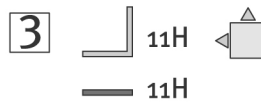

Frames 68/68/57/46

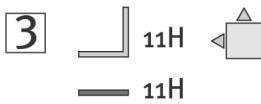

Frames 79/79/68/57

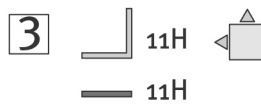

For more information about our products and services or to see a list of dealers, please visit us at HermanMiller.com or call (800) 851 1196.

© 2018 Herman Miller, Inc., Zeeland, Michigan

® **HermanMiller**, 3D Intelligent, AO, Action Office, Aeron, ArcSpan, Aside, Avall, Avive, Bubble Lamps, Canvas Office Landscape, Caper, Celle, Co/Struc, Daisiyone, Distil, Eames, Eco-Dematerialized, Embody, Envelop, Equa 2, Ergon 3, Ethospace, Exclave, Fine-Tune, FlexFront, Flo, Formcoat, Formwork, Ground Cloth, Herman Miller for the Home, Herman Miller for Healthcare, Intersect, Kinemat, Lapjack, Layout Studio, Lifework, Limerick, Live Unframed, Living Office, Locale, Maharam, Meridian, Mirra, Passage, Pellicle, Perspectives, PostureFit, Public Office Landscape, Resolve, Rodney, Sayl, Setu, Thrive, Tu, Wishbone, and Y-Tower are among the registered trademarks of Herman Miller, Inc., and its owned subsidiaries.

™ 8Z Pellicle, About Face, AireWeave, Albert, Backfit, Bubbletack, Burdick Group, Butterfly Back, Celeste, Cellular Suspension, Clam, Compass, Connect, Cosm, Cubert, DOT, Duracare, Durawrap, Eames Soft Pad, EnhancedAccess, Everywhere, Flex-Edge, Flute, Harmonic, Herman Miller Select, Hopsak 2, Intent, Iota, Jaw, Keyless Entry, Keyn Chair Group by Herman Miller, Latitude, Lino, Locale, Logic Mini, Logic Power Access Solutions, Live OS, Loop, Lyris, Lyris 2, Made-to-Measure Storage, Metaform Portfolio, Mora, Motia, Multiscrim, Nelson, Pari, Pixelated Support, Plex, PostureFit SL, Prospect, Q, Renew, Sense, Soft Pad, Stackable, Stackable Storage, Striad, Swoop, Tone, TriFlex, Twist, Ubi, Verus and Wireframe are among the trademarks of Herman Miller, Inc., and its owned subsidiaries.

SM Herman Miller Options is among the service marks of Herman Miller, Inc.

Alexander Girard® is a registered trademark of The Alexander Girard Estate.

Chemsurf® is a registered trademark of Wilsonart International.

Corian® is a registered trademark of E. I. du Pont de Nemours and Company Corporation.

Crypton® is a registered trademark of Crypton, Inc.

DACRON® is a registered trademark of INVISTA S.a r.l.

Edelman® Leather is a registered trademark of Edelman Leather, Inc.

FENIX NTM® is a registered trademark of Arpa Industriale S.p.A.

FLEXNET™ is a trademark of Milliken & Company.

Floor Saver Glide® is a registered trademark of Carpin Manufacturing, Inc.

Geiger® is a registered trademark, and Bumper™, Saiba™, and Ward Bennett™ are trademarks, of Geiger International.

Goetz™ is a trademark of Mark W. Goetz.

Hang-It-All® is a registered trademark of Lucia Eames Demetrios, d.b.a. Eames Office.

Holophane® is a registered trademark of Holophane.

Ingeo™ is a trademark of Cargill Dow LLC.

iPad® is a registered trademark of Apple, Inc.

LifeSize® is a registered trademark of LifeSize Communications, Inc.

Magis®, Bombo®, and Me Too® are registered trademarks of Magis S.p.A.

Microsoft® and Natural® Keyboard are registered trademarks of Microsoft Corporation.

Noguchi® and the Noguchi table configuration (trade dress) are registered trademarks, and Rudder Table™ is a trademark, of The Isamu Noguchi Foundation and Garden Museum.

Place Textiles® is a registered trademark of Place Textiles.

SuperSeat™ is a trademark of Dahti Seating, a division of ITW.